

NEOLINEO/V

Estrattori in linea per condotti con corpo estraibile
e dimensione ridotta con cuscinetti a sfere a lunga durata



Ventilazione

La tecnologia per
il benessere di ogni respiro



Prodotto

NEOLINEO/V

Costruzione

Involucro: materiale plastico autoestinguibile V0
Finitura: materiale plastico, di colore bianco,
autoestinguibile al fuoco V0

VENTILATORE

Morsettiera esterna, con posizione variabile.

I modelli T sono dotati di temporizzatore.

MOTORE

Motore con cuscinetti a sfera a lunga durata.

Protezione IPX4, a due velocità e regolabili.

Monofase 220-240V. 50/60 Hz.

Temperatura di esercizio: -10°C
+60°C.

INSTALLAZIONE

Installazione rapida e semplice.

DIMENSIONALI

Modello	Dimensioni (mm)			
	A	B	C	ØD
NEOLINEO-100/V	302,5	195,8	226	97
NEOLINEO-100/V T	302,5	195,8	226	97
NEOLINEO-125/V	258,5	195,6	226	123
NEOLINEO-125/V T	258,5	195,6	226	123
NEOLINEO-150/V	289	220,1	247	148
NEOLINEO-150/V T	289	220,1	247	148
NEOLINEO-160/V	289	220,1	247	158
NEOLINEO-160/V T	289	220,1	247	158
NEOLINEO-200/V	295,5	239	261	199
NEOLINEO-200/V T	295,5	239	261	199
NEOLINEO-250/V	383	287	323	247
NEOLINEO-315/V	445	362	408	310

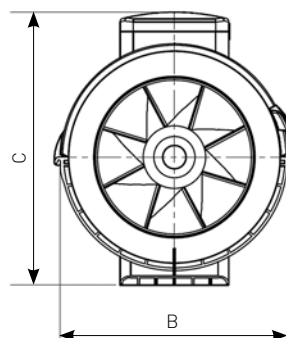
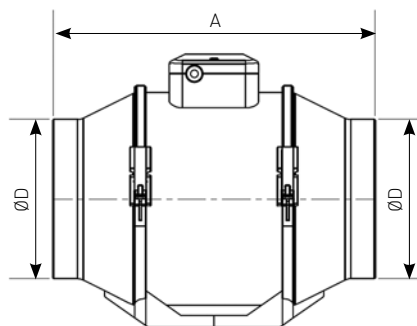

NEOLINEO/V

NEOLINEO/V

Estrattori in linea per condotti con corpo estraibile
e dimensione ridotta con cuscinetti a sfere a lunga durata

CARATTERISTICHE TECNICHE

Modello standard	Velocità RPM	Tensione V	Frequenza/ fasi Hz	Intensità max. consentita A	Potenza kW*	Portata max. m ³ /h	Livello della potenza sonora dB(A)	Peso appross. kg
NEOLINEO-100/V	2500	220-240	50/1	0,20	0,03	187	59	1,5
NEOLINEO-125/V	2500	220-240	50/1	0,26	0,04	280	61	1,4
NEOLINEO-150/V	2450	220-240	50/1	0,27	0,06	521	66	2,7
NEOLINEO-160/V	2450	220-240	50/1	0,27	0,06	521	65	2,7
NEOLINEO-200/V	2510	220-240	50/1	0,55	0,13	1046	69	4,0
NEOLINEO-250/V	2440	220-240	50/1	0,79	0,13	1397	68	7,8
NEOLINEO-315/V	2660	220-240	50/1	1,98	0,33	2035	70	11,9

CURVE CARATTERISTICHE

NEOLINEO 100/V

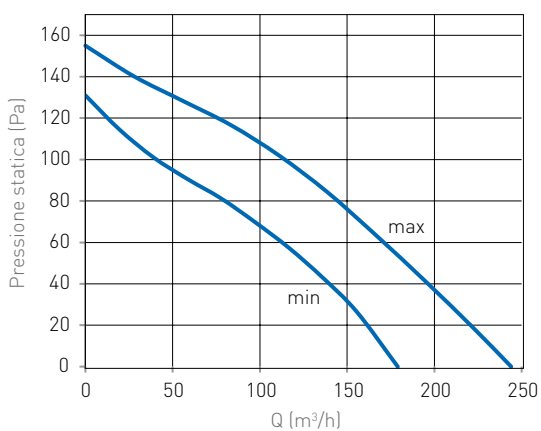

NEOLINEO 125/V

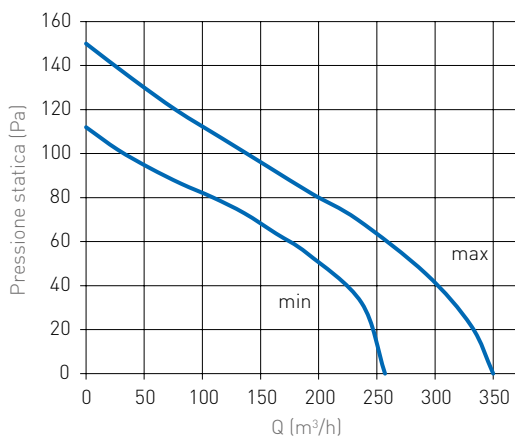

NEOLINEO 150/V

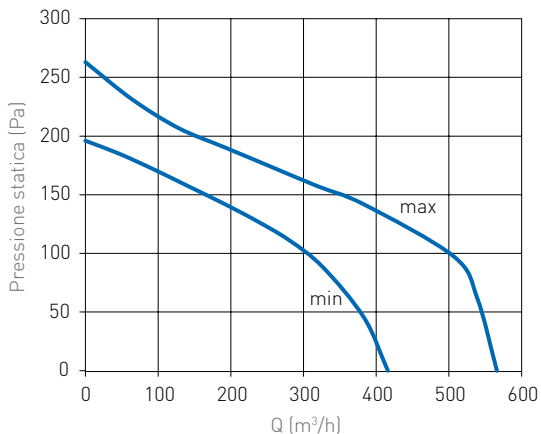

NEOLINEO 160/V

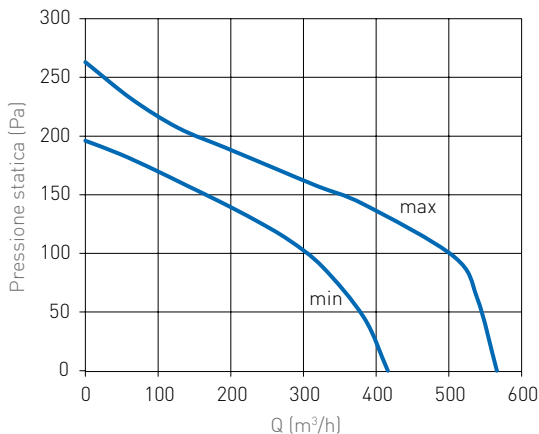



NEOLINEO 200/V

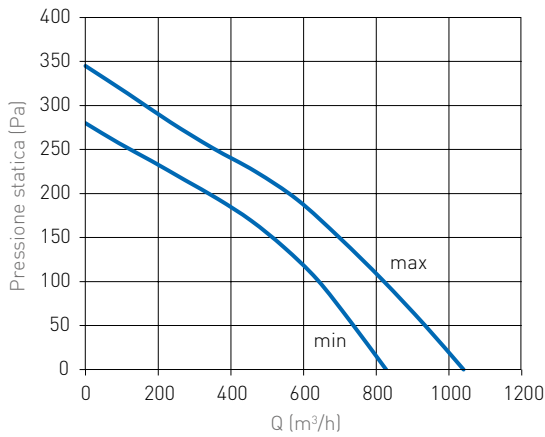

NEOLINEO 250/V

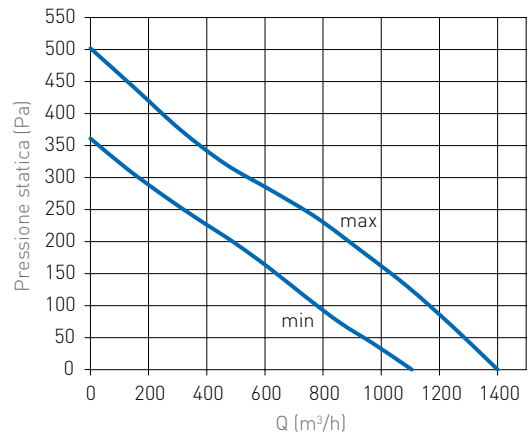

NEOLINEO 315/V

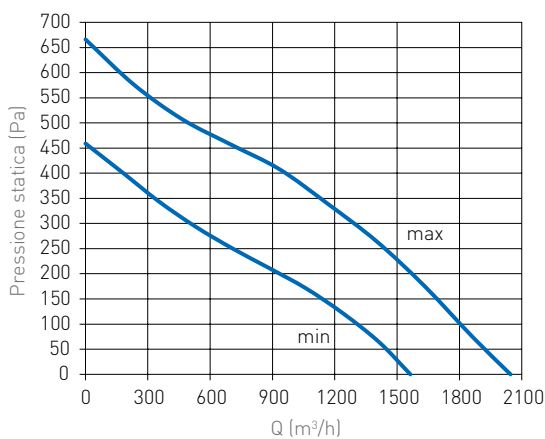

ACCESSORI



Kit di installazione
in serie (tubo)



Piastra
di installazione
in serie

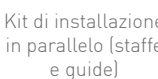

Kit di installazione
in parallelo (staffe
e guide)



Paratoie anti-ritorno



Griglie fisse



Regolatori elettronici
di velocità



Casse dei filtri d'aria



Batterie elettriche



DUO
Interruttore a due
velocità



Sensori intelligenti



Entrate dell'aria
per abitazioni



Bocchette di uscita
per abitazioni



Silenziatore

Tutte le immagini sono soltanto indicative della tipologia di prodotto e possono differire dall'articolo.